



🇬🇧 Spare parts for

Ice makers, Granita machines and Beverage equipment

🇮🇹 Ricambi per

Produttori di Ghiaccio, Granitori e Impianti di Spillatura



2019



Contents

Sommario



ICE MAKERS

- 3 Drip trays for ice makers
- 4 Solenoid valves
- 5 Floats
- 5 Microswitches, magnetic
- 6 Motors
- 7 Electric pumps
- 8 Microswitches, mechanical
- 9 Gearmotors
- 10 Controllers and changeover switches
- 11 Electronic boards
- 12 Sensors
- 13 Thermostats

PRODUTTORI DI GHIACCIO

- 3 Bacinelle produttori di ghiaccio
- 4 Elettrovalvole
- 5 Galleggianti
- 5 Microinterruttori magnetici
- 6 Motori
- 7 Elettropompe
- 8 Microinterruttori meccanici
- 9 Motoriduttori
- 10 Programmatori e inversori ciclici
- 11 Schede elettroniche
- 12 Sensori
- 13 Termostati



GRANITA MACHINES

- 14 Drip trays for coffee and bar
- 14 Scrolls
- 15 Gaskets and seals
- 16 Motors
- 17 Gearmotors
- 18 Electronic boards
- 18 Thermostats
- 19 Drip tanks

GRANITORI

- 14 Bacinelle raccogliocce caffè e bar
- 14 Coclee
- 15 Guarnizioni
- 16 Motori
- 17 Motoriduttori
- 18 Schede elettroniche
- 18 Termostati
- 19 Vasche





BEVERAGE EQUIPMENT

- 20 Refrigerators condensers
- 21 Electric pumps
- 21 Solenoid valves
- 22 Motors
- 23 Dispenser taps and accessories
- 23 Thermostats

IMPIANTI DI SPILLATURA

- 20 Condensatori frigoriferi
- 21 Elettropompe
- 21 Elettrovalvole
- 22 Motori
- 23 Rubinetti per distributori ed accessori
- 23 Termostati



 Drip trays for ice makers
 Bacinelle produttori di ghiaccio



3015060

 **DRIP TRAY ASSEMBLY**
 234x125 mm

 **ASSIEME BACINELLA**
 234x125 mm

ITV 105360

ITV 5360

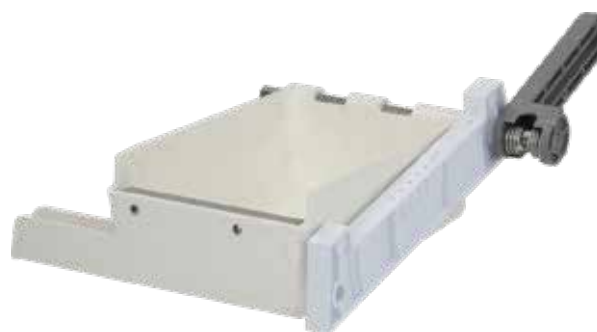

5059591

 **DRIP TRAY ASSEMBLY**
 180x126 mm

 **ASSIEME BACINELLA**
 180x126 mm

ICEMATIC 8140004



3006001

 **DRIP TRAY ASSEMBLY**
 180x120 mm

 **ASSIEME BACINELLA**
 180x120 mm

BARLINE CM81403005
 SIMAG CM81403005

ICEMATIC 81403005

SCOTSMAN CM81403005

3006005

 **DRIP TRAY ASSEMBLY**
 180x445 mm

 **ASSIEME BACINELLA**
 180x445 mm

BARLINE CM81423002
 SIMAG CM81423002

ICEMATIC 81423002

SCOTSMAN CM81423002

5033816

 **DRIP TRAY WITH PIN**
 195x135 mm

 **BACINELLA CON PERNO**
 195x135 mm



BREMA C10484
 SPAZIALE NC10484

NTF NC10484

RANCILIO 68010484





 Solenoid valves
 Elettrovalvole



3120191

 **SOLENOID VALVE
2-WAY 90°**

220/240V 50/60Hz -
max temperature 90°C
inlet 3/4" - two outlets ø 10,5 mm
2 outlets with orange adjust. 2.5L/min

ALPENINOX 085339
ELECTROLUX PROFESSIONAL 085339
EVERLASTING
NTF N23157
ZANUSSI 71085339

BREMA 23157
EMMEPI 23157
FAGOR 12034115
ZANUSSI 085339
ZANUSSI BRE000023157

BRICE 926118
EMMEPI 809329
FAGOR BR00023157
ZANUSSI 23157



3120276

 **SOLENOID VALVE RPE
2-WAY 180°**

220/240V 50Hz -
max. temperature 90°C
inlet 3/4" - two outlets ø 10,5 mm
1 outlet with adjuster 1.1 L/min
1 outlet with adjuster 2.7 L/min

MACH 80002DR067

MIGEL 2DR067

 **ELETTROVALVOLA
2 VIE 90°**

220/240V 50/60Hz -
temperatura max 90°C
entrata da 3/4" - 2 uscite ø 10,5 mm
2 uscite con riduttori gialli 2,5 L/min

 **ELETTROVALVOLA RPE 2
VIE 180°**

220/240V 50Hz -
temperatura max 90°C
entrata da 3/4" - due uscite ø 10,5 mm
1 uscita con riduttore bianco 1,1L/min
1 uscita con riduttore nero 2,7 L/min



3120381

 **SOLENOID VALVE T&P
2-WAY 180°**

220/240V 50/60Hz -
max. temperature 90°C
inlet 3/4" - two outlets ø 10,5 mm
1 outlet with brown adjuster 1.2L/min
1 outlet with yellow adjuster 2.5L/min

ALPENINOX 084490
BARLINE 650105.70
SCOTSMAN 650105.51
SIMAG 650105.51
ZANUSSI 084490
ZANUSSI 65010551
ZANUSSI 71084490

BARLINE 650105.51
ELECTROLUX PROFESSIONAL 084490
SCOTSMAN 650105.62
SIMAG 650105.62
ZANUSSI 482598168
ZANUSSI 65010562
ZANUSSI 75C065010551

BARLINE 650105.62
ICEMATIC XP65010551
SCOTSMAN 650105.70
SIMAG 650105.70
ZANUSSI 554084490
ZANUSSI 65010570



3120194

 **SOLENOID VALVE ANGLE
RPE 806**

230V 50/60Hz
orifice 7 mm
inlet/outlet hose end fitting ø 10 mm
- food grade

ALPENINOX 0H9328
BARLINE 620460.01
SCOTSMAN 620460.00
SIMAG 620460.00
ZANUSSI 0H9328
ZANUSSI 710H9328

BARLINE 060564.00
ELECTROLUX PROFESSIONAL 0H9328
SCOTSMAN 620460.01
SIMAG 620460.01
ZANUSSI 30001132
ZANUSSI SC00062040601

 **ELETTROVALVOLA AD
ANGOLO RPE 806**

230V 50/60Hz
orificio 7 mm
entrata/uscita portagomma ø 10 mm
- alimentare

BARLINE 620460.00
SCOTSMAN 060564.00
SIMAG 060564.00
ZANUSSI 06056400
ZANUSSI 62040601



3120237

 **SOLENOID VALVE DELTROL CONTROLS
DSVP12N**

230V 50/60Hz 16W
hose-end fitting inlet ø 17,4 mm - outlet ø 16 mm
intermittent work cycle
2LSX-240M 74017-69

MANITOWOC 000001768

MANITOWOC 000014063

MANITOWOC 2404903

 **ELETTROVALVOLA DELTROL CONTROLS
DSVP12N**

230V 50/60Hz 16W
portagomma inlet ø 17,4 mm - outlet ø 16 mm
ciclo lavoro intermittente
2LSX-240M 74017-69



-  Floats
-  Galleggianti



3527166

 **FLOAT VALVE**

connection M11 x ø 6 mm

 **VALVOLA GALLEGGIANTE**

attacco M11 x ø 6 mm.

- | | |
|----------------------|--------------------------------|
| ALPENINOX 086580 | BARLINE 02002217.02 |
| BARLINE CM19864010 | ELECTROLUX PROFESSIONAL 086580 |
| ICEMATIC 19864010 | ICEMATIC 19864011 |
| SCOTSMAN 02002217.02 | SCOTSMAN CM19864010 |
| SIMAG 02002217.02 | SIMAG CM19864010 |
| ZANUSSI 086580 | |



5030057

 **FLOAT VALVE**

fastening threads M14 mm - pipe fitting ø 6 mm

 **VALVOLA GALLEGGIANTE**

filetto fissaggio M14 mm - raccordo per tubo ø 6 mm

- | | |
|---------------------------|----------------------------|
| ICE-O-MATIC IOM9131111.01 | ICE-O-MATIC IOM9131111.101 |
|---------------------------|----------------------------|



3527015

 **FLOAT VALVE**

 **VALVOLA GALLEGGIANTE**

- | | |
|-------------------|--------------------------------|
| ALPENINOX 087813 | BREMA 10188 |
| BREMA C10188 | ELECTROLUX PROFESSIONAL 087813 |
| EVERLASTING | NTF N10188 |
| ZANUSSI 087813 | ZANUSSI 10188 |
| ZANUSSI 554087813 | ZANUSSI 71087813 |

-  Microswitches, magnetic
-  Microinterruttori magnetici



3240256

 **MAGNETIC MICROSWITCH STEM E550 1B**

1 contact NO 250V 1A 50W
cable length 1200 mm

 **MICROINTERRUTTORE MAGNETICO STEM E550 1B**

1 contatto NO 250V 1A 50W
lunghezza cavo 1200 mm

- | | |
|------------------------|------------------------|
| AFINOX 74742196 | AFINOX 74742200 |
| ANGELO PO 32W2160 | DESCO C8310-00 |
| EMMEPI TR0666 | FOINOX 70201 |
| GIGA SDTR0666 | INDESIT 483286001174 |
| INDESIT 483286008761 | INDESIT C00336530 |
| INDESIT C00497167 | INOXTREND C8310-00 |
| SAGI 32W2160 | SILANOS 909105 |
| SILANOS TR0666 | WHIRLPOOL 483286001174 |
| WHIRLPOOL 483286008761 | |



5047599

 **MIRCOSWITCH MAGNETIC FOR CURTAIN**

magnet 26x12x7 mm with double sided sticker
cable length 1900 mm

 **MICROINTERRUTTORE MAGNETICO PER TENDINA**

magnete 26x12x7 mm con biadesivo
lunghezza cavo 1900 mm

- | | |
|----------------------|----------------------|
| BARLINE 11000563.01 | BARLINE 11000563.06 |
| SCOTSMAN 11000563.01 | SCOTSMAN 11000563.06 |
| SIMAG 11000563.01 | SIMAG 11000563.06 |



3240498

 **MAGNETIC MICROSWITCH STEM D102 1B**



1-NO 1A 250V 50W - cylindrical deflector ø 10x33 mm
thread M10x0,75 - cable length 2000 mm

 **MICROINTERRUTTORE MAGNETICO STEM D102 1B**

1-NO 1A 250V 50W - sensore cilindrico ø 10x33 mm
filetto M10x0,75 - lunghezza cavo 2000 mm

- | | |
|-------------------|---------------------|
| ANGELO PO 32W1890 | ANGELO PO 32W3460 |
| BERTO'S 25850200 | EMMEPI 32W3460 |
| FOINOX 10419 | LA MINERVA 20963000 |
| MBM 32W1890 | OMEGA 20963000 |
| REPAGAS 65100001 | SAGI 32W1890 |
| SAGI 32W3460 | SIRMAN IV5820510 |
| SIRMAN LF1033302 | |



 Motors
 Motori



3240646

 **MOTOR BROAD-OCEAN
Y4S403D02G**

230V 50/60Hz 0.34A 1550rpm
with thermal protection
ex FASCO U90B1

MANITOWOC 2412939

 **MOTORE BROAD-OCEAN
Y4S403D02G**

230V 50/60Hz 0,34A 1550rpm
con protezione termica
ex FASCO U90B1



3240567

 **MOTOR MIXER COPREL
MIX 15-1 INC BB**

230V 50Hz

FONASA 0000461

 **MOTOAGITATORE COPREL
MIX 15-1 INC BB**

230V 50Hz



3240944

 **MOTOR REBO RM63/50**

230V 50/60Hz 115W 0.55A 1400rpm

ITV 205260

ITV 5260

 **MOTORE REBO RM63/50**

230V 50/60Hz 115W 0,55A 1400rpm



3240529

 **MOTOR RPM 11037704**

230V 50/60Hz 184W 1/4Hp 1,5A
with starting capacitor 10 μ F

MACH 80001LT027

MIGEL 1LT027

 **MOTORE RPM 11037704**

230V 50/60Hz 184W 1/4Hp 1,5A
con condensatore di spunto 10 μ F

RPM 110377.03



5004173

 **MOTOR EMI 82E-3016/11**

230V 50/60Hz 16/75W 1300rpm
with bracket fastening 4 screws M4
distance 26x21 mm
shaft length 13.5 mm
cable length 1000 mm

BARLINE 620419.04
 ICEMATIC 18562058
 SCOTSMAN CM18562058

 **MOTORE EMI 82E-3016/11**

230V 50/60Hz 16/75W 1300rpm
con fissaggio a staffa 4 viti M4
distanza 26x21 mm
lunghezza albero 13.5 mm
lunghezza cavo 1000 mm

EMI 4126.1854
 SCOTSMAN 620419.04
 SIMAG CM18562058



Electric pumps
 Elettropompe



3122379

ELECTRIC PUMP FIR 4240.2300

120W 230V 50/60Hz 0,6A c.l.F connections ø 22 mm

ALPENINOX 089699
BRICE 926152
EMMEPI 8C1356
EVERLASTING
FIR ELETTROMECCANICA 4240
NTF NC23377
ZANUSSI 23377

BREMA C23377
COOKMAX
EMMEPI 8C1357
FAGOR 12028429
MBM C23377
RANCILIO 68023377
ZANUSSI 7BRE23377

BREMA RC23377
ELECTROLUX PROFESSIONAL 089699
EMMEPI EB1110003
FAGOR BR00023377
NTF N23377
ZANUSSI 089699



3122281

ELECTRIC PUMP REBO NR 63/35

120W 230V 50/60Hz 0,6A c.l.F connections ø 29 e 26 mm with insulating cover

ALPENINOX 085322
BREMA RC23002
ELECTROLUX PROFESSIONAL 085322
EMMEPI 808236
FAGOR BR00023002
NTF NC23002
WHIRLPOOL 185322
ZANUSSI 23002
ZANUSSI B23002

BREMA 23002
COLGED RICO002004
ELETTRORAR RICO002004
EVERLASTING
FIR ELETTROMECCANICA
RANCILIO 68023002
ZANUSSI 0780085322
ZANUSSI 7BRE23002
ZANUSSI BRE0000023002

ELETTROPOMPA REBO NR 63/35

120W 230V 50/60Hz 0,6A c.l.F attacchi ø 29 e 26 mm con ricopertura isolante

BREMA C23002
COOKMAX
EMMEPI 23002
FAGOR 12028445
MBM RICO002004
RANCILIO 68023051
ZANUSSI 085322
ZANUSSI 71085322
ZANUSSI BRE0000023051



3122010

ELECTRIC PUMP REBO MH30F1 LH

30W 230V 50Hz c.l.B - connections ø 13 mm Alternative GRE 620433-00

ELETTROPOMPA REBO MH30F1 SX

30W 230V 50Hz c.l.B - attacchi ø 13 mm Alternativa GRE 620433-00

ALPENINOX 086047
ANGELO PO 32M5830
BARLINE 620433.00
BARLINE 793113.27
ELECTROLUX PROFESSIONAL 086047
FAEMA 0000125070
GIGA 179311327
GIGA 179311327
ICEMATIC CS62043300
SAGI 32M6310
SCOTSMAN 793113.00
SCOTSMAN 793113.27R
SIMAG 793113.00
SIMAG 793113.27R
WHIRLPOOL 186389
ZANUSSI 086054
ZANUSSI 71086054

ALPENINOX 086054
ANGELO PO 32M6310
BARLINE 793113.00
BARLINE 793113.27R
ELECTROLUX PROFESSIONAL 086054
FOSTER 15315827
GIGA 162043300
ICEMATIC 19550113
SAGI 32M5830
SCOTSMAN 620433.00
SCOTSMAN 793113.27
SIMAG 620433.00
SIMAG 793113.27
WHIRLPOOL 186047
ZANUSSI 086047
ZANUSSI 79311327R



3122904

ELECTRIC PUMP COPREL P40 TBB

50W 230V 50/60Hz c.l.F

ELETTROPOMPA COPREL P40 TBB

50W 230V 50/60Hz c.l.F

ITV 205113
ITV 5113

ITV 205176
ITV 5176



3122204

ELECTRIC PUMP GRE 620430-00

50W 230V 50Hz - with STAINLESS STEEL bracket connections inlet ø 15 mm - outlet ø 21 mm for new type maker without motoagitator interchangeable with REBO MH50F 60W

ELETTROPOMPA GRE 620430-00

50W 230V 50Hz - con staffa INOX attacchi entrata ø 15 mm - uscita ø 21 mm per fabbricatore tipo nuovo senza motoagitatore intercambiabile con REBO MH50F 60W

ALPENINOX 086166
BARLINE 060523.00
BARLINE 670002.12
ELECTROLUX PROFESSIONAL 086166
GRE 620430
SCOTSMAN 620430.00
SCOTSMAN 793146.00
SIMAG 620430.00
SIMAG 793146.00
ZANUSSI 06052300
ZANUSSI 0KM739
ZANUSSI 62043000
ZANUSSI 75C06052300
ZANUSSI SC00006052300

ALPENINOX 0KM739
BARLINE 620430.00
BARLINE 793146.00
ELECTROLUX PROFESSIONAL 0KM739
SCOTSMAN 060523.00
SCOTSMAN 670002.12
SIMAG 060523.00
SIMAG 670002.12
WHIRLPOOL 186166
ZANUSSI 086166
ZANUSSI 554086166
ZANUSSI 71086166
ZANUSSI 75C062043000
ZANUSSI SC00062043000



 Microswitches, mechanical
 Microinterruttori meccanici



3240351

 **FLOAT MICROSWITCH**
CROUZET EF83161.5

1NO + 1NC 4A 250V
fastenig height 8 mm

BARLINE CM81409179
SAB ITALIA 81404080

 **MICRO GALLEGGIANTE**
CROUZET EF83161.5

1NO + 1NC 4A 250V
altezza fissaggio 8 mm

ICEMATIC 81404080
SCOTSMAN CM81409179

ICEMATIC 81409179
SIMAG CM81409179



3803060

 **FLOAT MICROSWITCH**
CROUZET EF83161.5

1NO + 1NC 4A 250V

MACH 80002SL001

 **MICRO GALLEGGIANTE**
CROUZET EF83161.5

1NO + 1NC 4A 250V

MIGEL 25L001



3240936

 **FLOAT MICROSWITCH**
CROUZET U83160.4

1NO + 1NC 6A 250V

ITV 105058

 **MICRO GALLEGGIANTE**
CROUZET U83160.4

1NO + 1NC 6A 250V

ITV 5058

WHIRLPOOL 483286001866



3240357

 **MICROFLOAT ROLD**
VRSRBRAA 1

1NO 3A 250V
complete with bracket

BRICE AS928040

 **MICROGALLEGGIANTE**
ROLD VRSRBRAA 1

1NO 3A 250V
completo di staffa

EURFRIGOR RH00A310

EURFRIGOR R100A241



Compressors

from the best brands,
always available

www.lfspareparts724.com



cubigel
compressors

embraco

SECOP

Tecumseh



- Gearmotors
- Motoriduttori



3240360

GEAR MOTOR LIP 133

230V 50Hz 11W 50rpm - Counterclockwise
ex 000E

MOTORIDUTTORE LIP 133

230V 50Hz 11W 50rpm - Antiorario
ex 000E

BARLINE CM19440059
EURFRIGOR RG000636
ICEMATIC 19440060
MACH 80001LT078
MONDIAL FRAMEC 4121002E
SCOTSMAN CM19440059
WHIRLPOOL 310054

BRICE 926061
ICEMATIC 19440059
KASTEL 601039
MIGEL 1LT078
NUOVA SIMONELLI 16000018
SIMAG CM19440059
WHIRLPOOL 771985006358



3240941

GEAR MOTOR MECHTEX MT6b GB5FS

230V 50Hz 3.5W 30rpm cw
ex CROUZET 82 334 5

MOTORIDUTTORE MECHTEX MT6b GB5FS

230V 50Hz 3,5W 30rpm cw
ex CROUZET 82 334 5

CODIGEL 42114020
ITV 105364

EUROFRANCE 105364
ITV 5364



5062756

GEARMOTOR GUAITANI CT/3 23800/2

230V 50/60Hz
with support, pins and support spring

MOTORIDUTTORE GUAITANI CT/3 23800/2

230V 50/60Hz
con supporto, perni e molla di sostegno

BREMA C26746

EBERHARDT C26746



2104748

GEAR MOTOR CROUZET 82514039

230V 50Hz 3.5W 1rpm
shaft \varnothing 4-10xh62 mm

WESSAMAT 32301

MOTORIDUTTORE CROUZET 82514039

230V 50Hz 3.5W 1rpm
albero \varnothing 4-10xh62 mm



3240940

GEAR MOTOR KELVIN

230V 50Hz



ITV 105200

MOTORIDUTTORE KELVIN

230V 50Hz

ITV 5200



 Controllers and changeover switches
 Programmatori e inversori ciclici



3322129

 **TIMER 11904
F1 4 CAMS 12 MINUTES**

230V 50/60Hz - without pin

ALPENINOX 023222
 ALPENINOX 23222
 ALPENINOX 71085324
 BREMA 23222
 ELECTROLUX PROFESSIONAL 023222
 ELECTROLUX PROFESSIONAL 23222
 ELECTROLUX PROFESSIONAL 71085324
 ELETTROMECC. CDC 11904F1BDE0000030
 EURFRIGOR RFS08869
 LUXIA 4695
 LUXIA N23222
 RANCILIO 68023222
 WHIRLPOOL 123222
 ZANUSSI 085324
 ZANUSSI 554085324
 ZANUSSI B23222

ALPENINOX 085324
 ALPENINOX 554085324
 ALPENINOX B23222
 BRICE 926070
 ELECTROLUX PROFESSIONAL 085324
 ELECTROLUX PROFESSIONAL 554085324
 ELECTROLUX PROFESSIONAL B23222
 EMMEPI 23222
 EVERLASTING
 LUXIA L4695
 NTF N23222
 SOTAL 439000582
 WHIRLPOOL 185324
 ZANUSSI OKL019
 ZANUSSI 7BRE23222
 ZANUSSI BRE000023222

ALPENINOX OKL019
 ALPENINOX 7BRE23222
 ALPENINOX BRE000023222
 COOKMAX
 ELECTROLUX PROFESSIONAL OKL019
 ELECTROLUX PROFESSIONAL 7BRE23222
 ELECTROLUX PROFESSIONAL BRE000023222
 EMMEPI 831088
 FAGOR BRO0023222
 LUXIA M06712020
 RANCILIO 68023003
 SPAZIALE 4715
 ZANUSSI 023222
 ZANUSSI 23222
 ZANUSSI 71085324



3322217

 **TIMER 11904
F1 4 CAMS 10 MINUTES**

230V 50/60Hz - without shaft

ALPENINOX 085285
 COOKMAX
 ELETTROMECC. CDC 11904F1BCE0000040
 EMMEPI 809346
 FAGOR BRO0023247
 RANCILIO 68023247
 ZANUSSI 085285
 ZANUSSI B23247

BREMA 23247
 ELECTROLUX PROFESSIONAL 085285
 ELETTROMECC. CDC 11904F1BCR0000000
 EVERLASTING
 LUXIA N23247
 SPAZIALE 3094
 ZANUSSI 23247
 ZANUSSI BRE000023247

BRICE 926138
 ELETTROMECC. CDC 11904F1BCE0000030
 EMMEPI 23247
 FAGOR 12030573
 NTF N23247
 WHIRLPOOL 185285
 ZANUSSI 71085285



3322125

 **TIMER CDC
15002F1**

230V 50/60Hz - 2 cams 15 min

ALPENINOX OKM738
 BRICE
 EURFRIGOR RES0A822
 SCOTSMAN 620431.00
 SIMAG Z1EL003
 ZANUSSI 62043100

BARLINE 620431.00
 ELECTROLUX PROFESSIONAL OKM738
 MACH 80001LT017
 SCOTSMAN Z1EL003
 STAFF ICE SYSTEM 30/12025000
 ZANUSSI 75CO62043100

BARLINE Z1EL003
 ELETTROMECC. CDC 15002F1BEE0000000
 MANITOWOC 2006649
 SIMAG 620431.00
 ZANUSSI OKM738
 ZANUSSI SCC0062043100



3322332

 **TIMER 11904 F1 4 CAMS 18
MINUTES**

230V 50/60Hz - without pin

BREMA 23396
 ELETTROMECC. CDC 11904F1BFR00000000
 NTF N23396

BREMA 23780
 EMMEPI 23396
 NTF N23780

ELETTROMECC. CDC 11904F1BFE00000030
 LUXIA N23780



5018711

 **TIMER 4902C1
2 CAMS 20 MINUTES**

230V 50/60Hz - C/W pack of timer adjusting pins

ELETTROMECC. CDC 4902C10BGR0001000
 ITV 380C
 NTF N23396

FAGOR 100380
 EMMEPI 23396
 NTF N23780

 **PROGRAMMATORE 4902C1
2 CAMME 20 MINUTI**

230V 50/60Hz

ITV 100380
 LUXIA N23780



 Electronic boards
 Schede elettroniche



3390013

 **ELECTRONIC CIRCUIT BOARD SFT 012**

with sensor

ALPENINOX 086294
 BARLINE 001028.09
 BARLINE 060711.00
 BARLINE 620403.20
 BARLINE 620462.06
 ELECTROLUX PROFESSIONAL OT4522
 SCOTSMAN 001028.09
 SCOTSMAN 060711.00
 SCOTSMAN 620403.20
 SCOTSMAN 620462.06
 SIMAG 028640.98
 SIMAG 620403.18
 SIMAG 620462.00
 ZANUSSI 0780086553
 ZANUSSI 0T4522
 ZANUSSI 62040318
 ZANUSSI 62046200

ALPENINOX 086553
 BARLINE 001028.09R
 BARLINE 620403.01
 BARLINE 620456.00
 ELECTROLUX PROFESSIONAL 086294
 ICEMATIC XG62046200
 SCOTSMAN 001028.09R
 SCOTSMAN 620403.01
 SCOTSMAN 620456.00
 SIMAG 001028.09
 SIMAG 060711.00
 SIMAG 620403.20
 SIMAG 620462.06
 ZANUSSI 086294
 ZANUSSI 30003532
 ZANUSSI 62040318+620404
 ZANUSSI 71086294

 **SCHEDA ELETTRONICA COMPLETA SFT 012**

completa di sensore

ALPENINOX 0T4522
 BARLINE 028640.98
 BARLINE 620403.18
 BARLINE 620462.00
 ELECTROLUX PROFESSIONAL 086553
 REPAGAS 41700007
 SCOTSMAN 028640.98
 SCOTSMAN 620403.18
 SCOTSMAN 620462.00
 SIMAG 001028.09R
 SIMAG 620403.01
 SIMAG 620456.00
 ZANUSSI 0780086294
 ZANUSSI 086553
 ZANUSSI 481853563
 ZANUSSI 62041803
 ZANUSSI 71086553



3390911

 **ELECTRONIC CIRCUIT BOARD SFT 025**

for GRANULATED ICE MAKERS

ALPENINOX 086576
 BARLINE 620403.03
 BARLINE 620462.02
 SCOTSMAN 060711.10
 SCOTSMAN 620403.09
 SCOTSMAN 620462.13
 SIMAG 620403.03
 SIMAG 620462.02
 ZANUSSI 62046202

BARLINE 060711.10
 BARLINE 620403.09
 BARLINE 620462.13
 SCOTSMAN 060711.11
 SCOTSMAN 620456.02
 SIMAG 060711.10
 SIMAG 620403.09
 SIMAG 620462.13
 ZANUSSI 75C062046202

 **SCHEDA ELETTRONICA SFT 025**

per produttori di ghiaccio granulari

BARLINE 060711.11
 BARLINE 620456.02
 ELECTROLUX PROFESSIONAL 086576
 SCOTSMAN 620403.03
 SCOTSMAN 620462.02
 SIMAG 060711.11
 SIMAG 620456.02
 ZANUSSI 086576



5053416

 **ELECTRONIC BOARD ICEMOD4-A**

dimensions 160x100 mm

ALPENINOX 086586
 ELECTROLUX PROFESSIONAL 086586
 ICEMATIC 33580250
 SCOTSMAN CM33580250
 ZANUSSI 086586

BARLINE CM33580150
 FOSTER 15315855
 NOSEM 33580150
 SIMAG CM33580150

 **SCHEDA ELETTRONICA ICEMOD4-A**

dimensioni 160x100 mm

BARLINE CM33580250
 ICEMATIC 33580150
 SCOTSMAN CM33580150
 SIMAG CM33580250

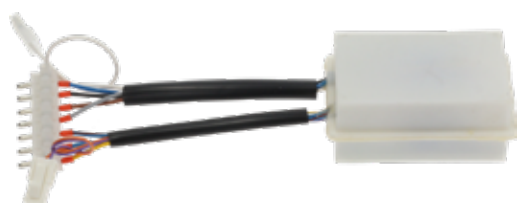

5051094

 **ELECTRONIC CIRCUIT BOARD MT276R0-2**

dimensions 115x98 mm

KASTEL K01471

KASTEL K04601

KASTEL K04720

 **SCHEDA ELETTRONICA MT276R0-2**

dimensioni 115x98 mm

3390446

 **ELECTRONIC-BOARD EK 150**

85x55 mm

WESSAMAT 41125

 **SCHEDA ELETTRONICA EK 150**

85x55 mm



🇬🇧 Sensors
🇮🇹 Sensori

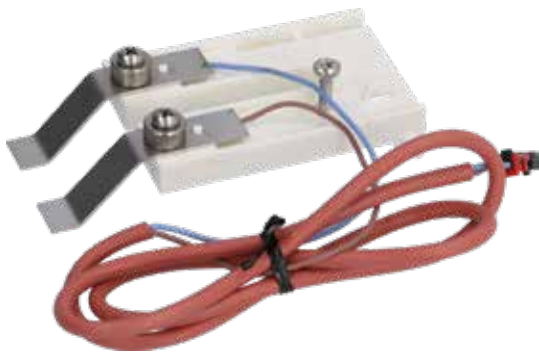

3390018

🇬🇧 **ICE THICKNESS SENSOR**

cable 850 mm

BARLINE CM81453007
FOSTER 15315701
ICEMATIC 81453434
NOSEM 81453434
SCOTSMAN CM81453434
SIMAG CM81453434

🇮🇹 **SENSORE CONTROLLO LIVELLO GHIACCIO**

cavo 850 mm

BARLINE CM81453114
ICEMATIC 81453007
NOSEM 81453007
SCOTSMAN CM81453007
SIMAG CM81453007
BARLINE CM81453434
ICEMATIC 81453114
NOSEM 81453114
SCOTSMAN CM81453114
SIMAG CM81453114



3390197

🇬🇧 **ICE LEVEL SENSOR**

cable 850 mm

MANITOWOC 2008029

🇮🇹 **SENSORE CONTROLLO LIVELLO GHIACCIO**

cavo 850 mm



3390015

🇬🇧 **CONDENSER TEMPERATURE SENSOR**

ALPENINOX 086340
BARLINE 620404.11
ICEMATIC 29070014
ICEMATIC XP62040401
SIMAG 620404.01
ZANUSSI OKM745
ZANUSSI 62040401
ZANUSSI 75C062040411

🇮🇹 **SENSORE TEMPERATURA CONDENSATORE**

ALPENINOX OKM745
ELECTROLUX PROFESSIONAL 086340
ICEMATIC CF62040401
SCOTSMAN 620404.01
SIMAG 620404.11
ZANUSSI 30003179
ZANUSSI 62040411
ZANUSSI SC00062040411
BARLINE 620404.01
ELECTROLUX PROFESSIONAL OKM745
ICEMATIC CF62040411
SCOTSMAN 620404.11
SIMAG 086340
ZANUSSI 481853565
ZANUSSI 71086340



3390011

🇬🇧 **SENSOR FOR EVAPORATOR TEMPERATURE**

cable length 1500 mm

ALPENINOX 086339
BARLINE 620404.10
ELECTROLUX PROFESSIONAL 086344
ICEMATIC 29070009
ICEMATIC XP62040410
SCOTSMAN 620404.10
ZANUSSI 0780086344
ZANUSSI 47400342
ZANUSSI 554086344
ZANUSSI 71086344

🇮🇹 **SENSORE TEMPERATURA EVAPORATORE**

lunghezza cavo 1500 mm

ALPENINOX 086344
COLGED /FRIO00002
ELETTRORBAR /FRIO00002
FOSTER 00-554665
ICEMATIC 29070013
MBM /FRIO00002
SIMAG 620404.00
ZANUSSI 086339
ZANUSSI 086339
ZANUSSI 482598007
ZANUSSI 62040410
ZANUSSI P1CA66P16UCS
BARLINE 620404.00
ELECTROLUX PROFESSIONAL 086339
FAGOR BA62040410
GIGA I62040410
ICEMATIC CF62040410
SCOTSMAN 620404.00
SIMAG 620404.10
ZANUSSI 086344
ZANUSSI 50086344004
ZANUSSI 71086339
ZANUSSI Z086344



3390291

🇬🇧 **ROTATION SENSOR PROBE**

ALPENINOX 099774
BREMA R231028
EMMEPI 23676
NTF NR231028
ZANUSSI 23676

🇮🇹 **SENSORE DI ROTAZIONE**

BREMA 231028
BREMA R23676
EVERLASTING
NTF NR23676
ZANUSSI 7BRE23676

BREMA 23676
ELECTROLUX PROFESSIONAL 099774
NTF N23676
ZANUSSI 099774



🇬🇧 Thermostats
🇮🇹 Termostati



3444156

🇬🇧 **EVAPORATOR THERMOSTAT K22 L1020**

3 contacts 6A 250V
capillary 2000 mm - bulb \varnothing 8x40 mm
COLD -20,5°C - WARM -1,0°C
with adjusting screw

ALPENINOX 086033
BARLINE 620201.00
RANCO K22L1020000
SCOTSMAN 620201.00
ZANUSSI 477897029

ANGELO PO 32V2280
ELECTROLUX PROFESSIONAL 086033
SAGI 32V2280
SIMAG 620201.00
ZANUSSI 62020100

ANGELO PO 32V4360
ICEMATIC 19797009
SAGI 32V4360
ZANUSSI 086033
ZANUSSI 71086033



3444530

🇬🇧 **THERMOSTAT EVAPORATOR RANCO K22 L1074**

3 contacts 6A 250V
capillary 1500 mm -bulb \varnothing 9.6x38 mm
COLD -19,5°C - WARM -1°C
screw regulation - ex ATEA A21-0064

ANGELO PO 32V4400
RANCO K22L1074001
SIMAG 620201.01

ATEA A21-0064
SAGI 32V4400

BARLINE 620201.01
SCOTSMAN 620201.01

🇮🇹 **TERMOSTATO EVAPORATORE K22 L1020**

3 contatti 6A 250V
capillare 2000 mm - bulbo \varnothing 8 x 40 mm
COLD -20,5°C - WARM -1,0°C
regolazione a vite

🇮🇹 **TERMOSTATO EVAPORATORE RANCO K22 L1074**

3 contatti 6A 250V
capillare 1500 mm -bulbo \varnothing 9.6x38 mm
COLD -19,5°C - WARM -1°C
regolazione a vite - ex ATEA A21-0064



3444968

🇬🇧 **THERMOSTAT FOR EVAPORATOR K22 L1081**

3 contacts 6A 250V - capillary length 2250 mm
COLD -22°C - WARM -3°C - with adjusting screw

ALPENINOX 085284
ALPENINOX 71087969
BREMA 23591
ELECTROLUX PROFESSIONAL 554085284
ELECTROLUX PROFESSIONAL R23591
FAGOR BR00023004
NTF N23591
WHIRLPOOL 187969
ZANUSSI 71085284

ALPENINOX 087969
ALPENINOX B23004
BRICE 926081
ELECTROLUX PROFESSIONAL 71085284
EMMEPI 807661
FAGOR BR00023591
RANCILIO 68023004
ZANUSSI 085284
ZANUSSI 71087969

ALPENINOX 23004
ALPENINOX B23591
ELECTROLUX PROFESSIONAL 085284
ELECTROLUX PROFESSIONAL 71087969
EURFRIGOR RFS08893
HOSHIZAKI P03758-01
RANCO K22L1081000
ZANUSSI 087969
ZANUSSI B23004

ALPENINOX 23591
ALPENINOX BRE0000023591
ELECTROLUX PROFESSIONAL 087969
ELECTROLUX PROFESSIONAL B23004
EURFRIGOR RFS08893
KASTEL K00080
SPAZIALE 3090
ZANUSSI 23004
ZANUSSI B23591

🇮🇹 **TERMOSTATO EVAPORATORE K22 L1081**

3 contatti 6A 250V - capillare 2250 mm
COLD -22°C - WARM -1,5°C - regolazione a vite

ALPENINOX 554085284
ALPENINOX R23591
ELECTROLUX PROFESSIONAL 23004
ELECTROLUX PROFESSIONAL B23591
EVERLASTING
KASTEL K02526
SPAZIALE 6418
ZANUSSI 23591
ZANUSSI BRE0000023591

ALPENINOX 71085284
BREMA 23004
ELECTROLUX PROFESSIONAL 23591
ELECTROLUX PROFESSIONAL BRE0000023591
FAGOR 12033335
NTF N23004
WHIRLPOOL 185284
ZANUSSI 554085284
ZANUSSI R23591



3444843

🇬🇧 **EVAPORATOR THERMOSTAT K22 L1082**

3 contacts 6A 250V
capillary 2000 mm

BREMA R23005
MBM R23005

EMMEPI R23005
NTF NR23005

🇮🇹 **TERMOSTATO EVAPORATORE K22 L1082**

3 contatti 6A 250V
capillare 2000 mm

LUXIA NR23005
RANCO K50L3121



3744125

🇬🇧 **THERMOSTAT FOR CONTAINER K50 L3121**

2 contacts 6A 250V - capillary 1500 mm
COLD +1,0°C - WARM +8,5°C
with adjusting screw

ALPENINOX
BREMA R23951
DIAMOND 98R23591
EVERLASTING
NTF N24727
RANCILIO 68023591
SOTAL 439000481

BREMA 24727
COOKMAX
ELECTROLUX PROFESSIONAL
LUXIA NR23591
NTF NR23591
RANCO K22L1082
ZANUSSI

🇮🇹 **TERMOSTATO CONTENITORE K50 L3121**

2 contatti 6A 250V - capillare 1500 mm
COLD +1,0°C - WARM +8,5°C
regolazione a vite

BREMA R23591
DIAMOND 98880014
EMMEPI R23591
MBM R23591
NTF NR23951
RANCO K22L1082000



Drip trays for coffee and bar
 Bacinelle raccogliogocce caffè e bar



1015041

DRIP TRAY BLACK
VASCHETTA RACCOGLIGOCCE NERA

GBG SL300970262
 SENCOTEL SL34000502

GBG SL34000502



1199120

DRIP TRAY WITH GRID
VASCHETTA CON GRIGLIA

CAB F059/F060
 CAB F059BM++F060BM
 CAB GV1G

CAB F059/N++F060/N
 CAB GV1B
 CAB GV1N



1015042

DRIP TRAY BLACK
VASCHETTA RACCOGLIGOCCE NERA

CAB F059/060N04

CAB GV2MODN

Scrolls
 Coclee



1199041

INTERNAL MIXER
MESCOLATORE INTERNO

overall length 332 mm

lunghezza totale 332 mm

BRAS 33800-08001
 UGOLINI 33800-08002

UGOLINI 33800-08001

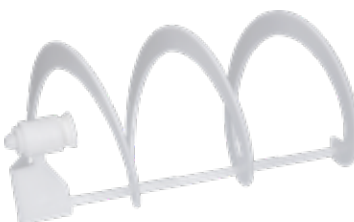

1199707

COMPLETE AUGER
ELICA COMPLETA

CAB F304/1

NUOVA SIMONELLI 16300107



1199435

SPIRAL STIRRING BLADE
SPIRALE MISCELATRICE

SPM 02.BA0020.002
 SPM 02.BA0266.SLU

SPM 02.BA0266.001



1199320

NEW SCROLL ADAPTER KIT
KIT ADATTATORE NUOVA COCLEA

GBG SL300970005
 GBG SL310001772+
 STAFF ICE SYSTEM 970005
 STAFF ICE SYSTEM SL300970382

GBG SL300970382
 GBG SL310005008
 STAFF ICE SYSTEM 970382
 STAFF ICE SYSTEM SL310001772

GBG SL310001772
 SENCOTEL SL310001772
 STAFF ICE SYSTEM SL300970005
 STAFF ICE SYSTEM SL310005008



1199508



GRANITA MACHINE SCROLL
COCLEA GRANITORE

GBG SL300950224
 GBG SL3GS12009D
 STAFF ICE SYSTEM 30/0951600

GBG SL310005153
 GBG SL3GS12009D
 STAFF ICE SYSTEM 950224

GBG SL320001599
 SENCOTEL SL3GS12009D
 STAFF ICE SYSTEM SL3GS12009D



 Gaskets and seals
 Guarnizioni



1199005

 **EXTERNAL EVAPORATOR GASKET**

BRAS 22800-17200

UGOLINI 02800-17200

 **GUARNIZIONE ESTERNA EVAPORATORE**

UGOLINI 22800-17200



1199322

 **EVAPORATOR GASKET ø 170 mm**

new type

GBG SL30006016
 GBG SL320001598
 SENCOTEL SL3GS36007B

 **GUARNIZIONE EVAPORATORE ø 170 mm**

tipo nuovo

GBG SL300950070
 GBG SL3GS36007B
 STAFF ICE SYSTEM 950070

GBG SL310000104
 GBG SL3GS36007B
 STAFF ICE SYSTEM SL3GS36007B



1786239

 **GASKET FOR DISPENSER TAP**

 **GUARNIZIONE RUBINETTO DISTRIBUTORE**

GBG SL310001915
 GBG SL320001759

GBG SL320001758
 SENCOTEL SL320001758



1186002

 **SUCTION GASKET FOR SCRAPER HOOKING**

 **GUARNIZIONE VENTOSA AGGANCIO RASCHIATORE**

GBG SL300951857
 STAFF ICE SYSTEM 951857

GBG SL320001630
 STAFF ICE SYSTEM SL300951857



1186021

 **SUCTION GASKET 63SH**

 **GUARNIZIONE A VENTOSA 63SH**

SPM 02.BA0025.001





Commercial refrigeration

All the spare parts.
One supplier.

www.lfspareparts724.com





 Motors
 Motori



1240369



MOTOR EMI 20W 82-2516/32

230V 50Hz 20W 0.60A 1300rpm

BRAS 22900-03010

EMI 82-2516/32



MOTORE EMI 20W 82-2516/32

230V 50Hz 20W 0,60A 1300rpm

UGOLINI 22900-03010



1240514



MOTOR EMI 16W 82E-2516

230V 50/60Hz 65W Input 1300rpm

BRAS 22800-18980

UGOLINI 22800-18980

EMI 4128.3408



MOTORE EMI 16W 82E-2516

230V 50/60Hz 65W Input 1300rpm

UGOLINI 02800-18980



1240510



MOTOR EMI 11W 82CE-2011/1

230V 50/60Hz 55W 1300rpm

BRAS 22800-04705

UGOLINI 22800-04705

BRAS 22800-18920

UGOLINI 22800-18920



MOTORE EMI 11W 82CE-2011/1

230V 50/60Hz 55W 1300rpm

UGOLINI 02800-04705



1198008



MOTOR EMI 82CE-2010 95

230V 50/60Hz 10/40W 1300rpm 0.3A

COFRIMELL 318
ELMECO C318

COFRIMELL 75
EMI 4110.3425



MOTORE EMI 82CE-2010 95

230V 50/60Hz 10/40W 1300rpm 0.3A

ELCO NET7U10ZVN001
EMI 4128.3430



Gearmotors
 Motoriduttori



1240301

**GEAR MOTOR ELCO
FR10-40-33 216**

115/230V 50/60Hz 70W 32rpm

ELCO 40181225
 GBG SL300950212
 STAFF ICE SYSTEM SL300950212

**MOTORIDUTTORE ELCO
FR10-40-33 216**

115/230V 50/60Hz 70W 32rpm

ELCO 40181231
 GBG SL3MS4M015C

ELCO 951023
 STAFF ICE SYSTEM 950212



3340194

**GEARMOTOR KENTA
K9357511**

230V 50Hz 58W 33rpm

GBG SL310001422
 KENTA K9357505B
 SENCOTEL SL310005299

GBG SL3MS4M015C
 KENTA K9357511

**MOTORIDUTTORE KENTA
K9357511**

230V 50Hz 58W 33rpm

KENTA K9357500
 SENCOTEL SL310001422

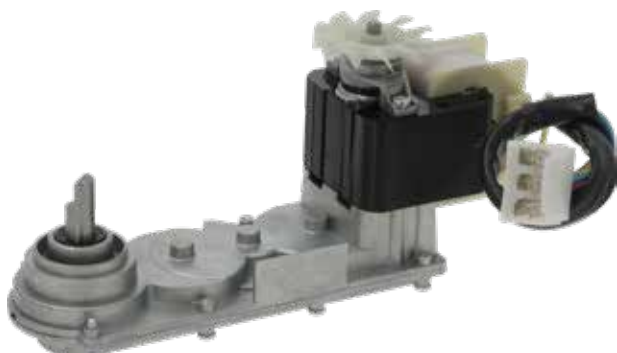

1240203

**GEAR MOTOR KENTA
K9357502**

115/230V 50/60Hz 53W 33rpm

CAB F033
 KENTA K9357502
 TECFRIGO B0848/1

**MOTORIDUTTORE KENTA
K9357502**

115/230V 50/60Hz 53W 33rpm

CAB F033/1
 NUOVA SIMONELLI 16300028

ELCO 40181226
 NUOVA SIMONELLI 16300077



3340171

**GEARMOTOR SPM
MNP40**

230V 50Hz 75W 33rpm

SPM 04.BA0178.001

SPM 05.BA0201.002

**MOTORIDUTTORE SPM
MNP40**

230V 50/60Hz 75W 33rpm



5025506

**GEAR MOTOR
230V 50Hz**

BRAS 33700-00010

**MOTORIDUTTORE
230V 50Hz**

UGOLINI 33700-00000

UGOLINI 33700-00010



Electronic boards
 Schede elettroniche



1199150

ELECTRONIC DELAY SWITCH
 230V 50Hz

RITARDATORE ELETTRONICO
 230V 50Hz

BRAS 22700-00600 UGOLINI 22700-00600



5038482

CIRCUIT BOARD
 E001-003/B3/01_04

230V 50/60Hz - 132x69 mm

SCHEDA ELETTRONICA
 E001-003/B3/01_04

230V 50/60Hz - 132x69 mm

ELMECO L0005101-001 ELMECO L0005105-001



5070360

CIRCUIT BOARD I-PRO 3 E+
 DIAPHRAGM KEYBOARD 8

SCHEDA I-PRO 3 E +
 TASTIERA A MEMBRANA 8

SPM 04.IP0222.002 SPM 05.IP0002.002

Thermostats
 Termostati



1444050

THERMOSTAT RANCO K50 P1127

2 contacts 6A 250V - capillary 1200 mm
 D-shaped pin 6x4 mm
 COLD +1.5°C WARM +12.5°C

TERMOSTATO RANCO K50 P1127

2 contatti 6A 250V - capillare 1200 mm
 perno mezzaluna 6x4 mm
 COLD +1.5°C WARM +12.5°C

COFRIMELL 64 ELMECO TK50P1127 OZTIRYAKILER ELMECO C64 NECTA VENDING 985528 RANCO K50P1127000



1444106

RANCO THERMOSTAT K50 L3100

2 contacts 6A 250V - capillary 1000 mm
 D-shaped pin ø 6x4.6 mm
 COLD -2.0°C WARM +11°C

TERMOSTATO RANCO K50 L3100

GBG SL300372061 SPM 04.DA0002.001 STAFF ICE SYSTEM SL300372061 RANCO K50L3100001 STAFF ICE SYSTEM 372061



1444107



THERMOSTAT RANCO K50 L3231

2 contacts 6A 250V - capillary length 1200 mm
 COLD +1.5°C WARM +11°C

TERMOSTATO RANCO K50 L3231

2 contatti 6A 250V - capillare 1200 mm
 COLD +1.5°C WARM +11°C

GBG SL300350467 RANCO K50L3231002 STAFF ICE SYSTEM 350467 STAFF ICE SYSTEM SL37AAL3231 GBG SL37AAL3231 SPM 04.BA0031.001 STAFF ICE SYSTEM SL300350467

 Drip tanks
 Vasche



1199030

 **CONTAINER FOR GRANITA MACHINE 10 L**

BRAS 22800-17404
UGOLINI 22800-17404

 **CONTENITORE DISTRIBUTORE GRANITA 10 L**

UGOLINI 02800-17400

UGOLINI 22800-17400



1521006

 **GRANITA MACHINE TANK 6 L**

BRAS 22700-00200

 **VASCA GRANITORE 6 L**

UGOLINI 22700-00200



1199713

 **TANK FABY 10 L**

CAB F009

 **VASCA FABY 10 L**

CAB F410

NUOVA SIMONELLI 16300034



1199423

 **TANK 12 L**

SPM 02.BA0021.001

 **VASCA 12 L**



5063192

 **COMPLETE TANK I-PRO**

height 350 mm

SPM 02.IP0016.002

 **VASCA I-PRO COMPLETA**

altezza 350 mm



 Refrigerators condensers
 Condensatori frigoriferi

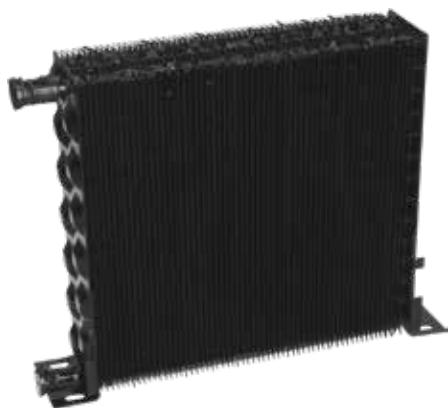

3123089

 **CONDENSER STFT 14121**
1x200 mm

output 1000W DT15°C
220x60x220h mm

CELLI 31360
LU-VE

 **CONDENSATORE STFT**
14221 1x200 mm

resa 1000W DT 15°C
220x60x220h mm

CEM INDUSTRIES 001059

COSMETAL 1601130

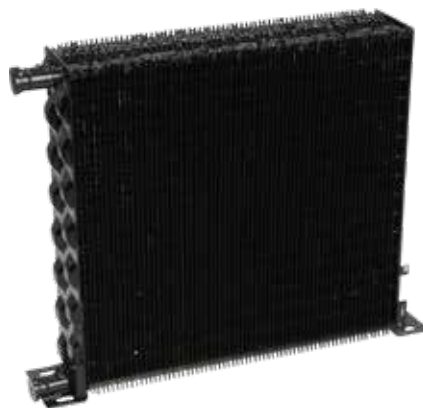

3123090

 **CONDENSER STFT 16224**
1x230 mm

output 1385W DT15°C
250x60x250h mm

ALPENINOX 088661

BREMA 20558
ELECTROLUX PROFESSIONAL 088661
EVERLASTING
LU-VE
NTF N20175
ZANUSSI 088661

BONNET 652252
CELLI 28636
ELMECO C082036007
FAGOR 12029656
MBM 20175
RANCILIO 68020175
ZANUSSI 20175

 **CONDENSATORE STFT**
16224 1x230 mm

resa 1385W DT15°C
250x60x250h mm

BREMA 20175
CEM INDUSTRIES 001218
EMMEPI 20175
FAGOR BR00020175
MBM 20558
THIRODE 652252
ZANUSSI 7BRE20175



3123095

 **PLASTIC FAN SHROUD**
CF21

dimensions 210x215 mm

CEM INDUSTRIES 003750

LU-VE

 **CONVOGLIATORE IN**
PLASTICA CF21

misure 210x215 mm



3123096

 **PLASTIC FAN SHROUD**
CF24

dimensions 240x245 mm

CEM INDUSTRIES 003490

LU-VE

 **CONVOGLIATORE IN**
PLASTICA CF24

misure 240x245 mm



 Electric pumps
 Elettropompe



3122495

 **PNEUMATIC PUMP SHURFLO 166-296-28**

syrup outlet tang 9.5 mm

CELLI 27394
FLOJET 6001500140

 **POMPA PNEUMATICA SHURFLO 166-296-28**
 codolo uscita 9,5 mm per scioppo

CEM INDUSTRIES 002231

EVERPURE 166-296-28



3122497



 **ELECTRIC PUMP SHURFLO SUK-0209 230V**

with pressure switch, timer and by-pass for wine/water

CELLI 19746

 **ELETTROPOMPA SHURFLO SUK-0209 230V**

con pressostato, timer e by-pass per vino/acqua

 Solenoid valves
 Elettrovalvole



3120350

 **SOLENOID VALVE RPE R-MINI 310 1 WAY 180°**

24Vac 50Hz - max. temperature 60°
inlet/outlet 1/4"F - series R Mini - foodgrade - NC
length 53 mm - height 60 mm

 **ELETTROVALVOLA RPE R-MINI 310 1 VIA 180°**

24Vac 50Hz - temperatura max 60°
entrata/uscita 1/4"F - serie R Mini - alimentare - NC
lunghezza 53 mm - altezza 60 mm

COSMETAL 2641124
WHIRLPOOL 310362

FOSTER 15320101
WHIRLPOOL 771985006460



3120649

 **SOLENOID VALVE RPE R-MINI 1146**
 12Vdc JG8mm

 **ELETTROVALVOLA RPE R-MINI 1146**

12Vdc JG8mm

COSMETAL 2641143



7150270

 **SOLENOID VALVE 5946 1/8" FF 24Vac**

with fixing feet M4
alternative CEME 5510
for REFRIGERATED FOUNTAIN FRP35-80-150

 **ELETTROVALVOLA OLAB 5946 1/8" FF 24Vac**

con piedini di fissaggio M4
alternativa CEME 5510
per FONTANA REFRIGERATA FRP35-80-150

OLAB 5946/P



 Motors
 Motori



3240803

 **MOTOR MIXER WITH PUMP
SAMEC MID-7**

230V 50Hz 64W 2750 Rpm
inlet and outlet 1/2"

CELLI 61210

 **MOTOAGITATORE CON
POMPA SAMEC MID-7**

230V 50Hz 64W 2750Rpm
entrata e uscita 1/2"



3240804

 **MOTOR MIXER WITH PUMP
SAMEC STR 7**

230V 50Hz 50W 2800 Rpm
inlet and outlet 1/2"

CELLI 48926

 **MOTOAGITATORE CON
POMPA SAMEC STR 7**

230V 50Hz 50W 2800Rpm
entrata e uscita 1/2"

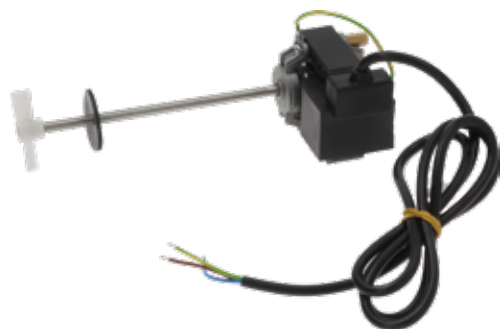

3240806

 **MOTOR MIXER TRIAL
AAA20C-010**

230V 50/60Hz 20W 0.17A 2400rpm

CELLI 52522

 **MOTOAGITATORE TRIAL
AAA20C-010**

230V 50/60Hz 20W 0.17A 2400rpm

CEM INDUSTRIES 005928

TRIAL AAA20C-010



3340191

 **MOTOR MIXER SAP H**

230V 50Hz 2800rpm 18W 0.14A
shaft dimensions \varnothing 7x165 mm

COSMETAL 17613010

 **MOTOAGITATORE SAP H**

230V 50Hz 2800rpm 18W 0.14A
dimensione albero \varnothing 7x165 mm



2105673

 **MOTOR MIXER SAP H-L**

230V 50Hz 2800rpm 18W 0.14A
shaft dimensions \varnothing 7x215 mm

CODIGEL 17613008

 **MOTOAGITATORE SAP H-L**

230V 50Hz 2800rpm 18W 0.14A
dimensione albero \varnothing 7x215 mm

CODIGEL 2817613008

COSMETAL 17613008

John Guest®

A range of fittings
and pipes to connect
your equipment





Dispenser taps and accessories
 Rubinetti per distributori ed accessori



3357032

CHROMEPLATED TAP FC2 WITH COMPENSATOR

threaded connection 5/8 - shaft length 35 mm
shaft hole ø 10 mm
with knob return spring - for beer not water

RUBINETTO FC2 CROMATO CON COMPENSATORE

attacco filettato 5/8 - lunghezza canotto 35 mm
ø foro canotto 10 mm
con molla di ritorno pomello - per birra no acqua

CELLI 46225



3357033

PLASTIC TAP FC4 WITH COMPENSATOR

threaded connection 5/8 - shaft length 35 mm
hole ø 24 mm
with knob return spring - for drinks and wine

RUBINETTO FC4 PLASTICA CON COMPENSATORE

attacco filettato 5/8 - lunghezza canotto 35 mm
ø foro 24 mm
con molla di ritorno pomello - per bevanda e vino

CELLI 47359



3357042

TAP EVO WITH COMPENSATOR CHROME PLATED

threaded fitting 5/8 - shaft length 56 mm
shaft hole ø 10 mm
with knob return spring

RUBINETTO EVO CROMATO CON COMPENSATORE

attacco filettato 5/8 - lunghezza canotto 56 mm
ø foro canotto 10 mm
con molla di ritorno pomello

CEM INDUSTRIES 008675

CEM INDUSTRIES 013419

Thermostats
 Termostati



5043354

THERMOSTAT RANCO K14 P0163

2 contacts 6A 250V
capillary 700 mm - spiral bulb

CODIGEL 283824929

COSMETAL 3824929

TERMOSTATO RANCO K14 P0163

2 contatti 6A 250V
capillare 700 mm - bulbo a spirale

RANCO K14P0163



3444835

RANCO THERMOSTAT K14 P0152

2 contacts 6A 250V
capillary 2000 mm
D-shaped pin ø 6x4.6 mm
COLD -2,5°C - WARM +6°C

CELLI 50286

RANCO K14P0152

TERMOSTATO RANCO K14 P0152

2 contatti 6A 250V
capillare 2000 mm
COLD -2,5°C - WARM +6°C
perno mezzaluna ø 6x4,6 mm



Distributing Spare Parts and Accessories worldwide

LF Spa a socio unico ITALY

via Voltri, 80 - 47522 Cesena (FC) ITALY
Tel. +39 0547 34 11 11 - Fax +39 0547 34 11 10
www.lfcombite724.it - info@lfcombite724.it
Export Dept. Tel. +39 0547 34 11 50 - Fax +39 0547 34 11 55
www.lfspareparts724.com - export@lfspareparts.com

EPGC Sas FRANCE

13, Rue des Forts - 59960 Neuville en Ferrain
Tel. +33 (0)3 20 25 06 21 - Fax +33 (0)3 20 25 34 12
www.epgc.com - epgc@epgc.com

LF GmbH GERMANY

Gadastr. 4 - 85232 Bergkirchen
Tel. 0800 99 39 399 - Fax +49 81 42 65 22 760
www.lfersatzteile724.de - info@lfersatzteile.de

OOO LF RUSSIAN FEDERATION

Ul. Anatoliya Zhivova, 8 - office 1 - 123100 Moscow
Tel./Fax +7 495 725 26 53
www.lfspareparts724.ru - info@lfspareparts.ru

LF Repuestos Horeca S.L.U. SPAIN

Polígono Industrial Carpetania - C/Miguel Faraday, 8 - 28906 Getafe
Tel. +34 91 477 91 00 - Fax +34 91 477 90 81
www.lfrepuestos-horeca724.es - info@lfrepuestos.es

LF Scandinavia Aps - LF Spareparts S.p.A. DENMARK

Nupark, 51 - 7500 Holstebro
Tel. +45 70 70 77 33
www.lfspareparts724.dk - denmark@lfspareparts.dk

LF Spare Parts Ltd. UNITED KINGDOM

A10a Lakeside Business Park, Broadway Lane
South Cerney, Gloucestershire GL7 5XL
Tel. +44 (0)1285 86 16 25 - Fax +44 (0)1285 86 39 49
www.lfspareparts724.co.uk - info@lfspareparts.co.uk

LF Central East Europe s.r.o. CZECH REPUBLIC

Antala Staška 1859/34
14000 Praha 4 - Krč
Tel. +420 234 129 707
www.lfspareparts724.cz - info@lfspareparts.cz

LF SPARE PARTS INC. USA

Legal address:
155 Office Plaza Dr - Suite A - Tallahassee, FL 32301
Business/Mailing address:
1100 South Tower, 225 Peachtree St., N.E. - Atlanta, GA 30303, USA
Tel. +1-404-525-2600 - Fax +1-404-586-3528
www.lfspareparts724.us - info@lfspareparts.us

AUSTRALIA AND NEW ZEALAND

www.lfspareparts724.com
andrea.calvio@lfspareparts.com

AUSTRIA

www.lfersatzteile724.at
info@lfersatzteile.at

BALKAN COUNTRIES

www.lfspareparts724.com
matija.ramov@lfspareparts.com

BALTIC COUNTRIES

www.lfspareparts724.com
inara.silina@lfspareparts.com

LATIN AMERICA AND THE CARRIBEANS

www.lfrepuestos-horeca724.es
export@lfrepuestos.es

POLAND

www.lfspareparts724.pl
info@lfspareparts.pl

SOUTH KOREA

www.lfspareparts724.com
asia@lfspareparts.com

TURKEY

www.lfyedekparca724.com
export@lfspareparts.com